



## **SUBMERSIBLE**

### **Flush Diaphragm Liquid Level Sensor AST4520**

#### **Overview**

The AST4520 Flush Submersible liquid level sensor is the cost effective solution for level monitoring of turbulent tanks with viscous media. Approved to UL/cUL913 Class 1 Division 1 IS, Groups C and D with an approved barrier, the product ensures a safe, reliable source for level measurement. The AST4520 is also certified to ATEX / IECEx Class I Zone 0 Exia IIB T4 Ga (Ta = -40°C to +80°C).

The AST4520 is offered with pressure ranges from 0-2.5 to 0-15 PSIG. The AST4520 steel cage front end design allows for proper flow of liquids while keeping the sensor at the bottom of the tank or well. With an engraved stainless steel housing and Kynar PVDF cable, this sensor is built to handle the toughest environments.

#### **Benefits**

- Engraved Housing
- Protective Steel Cage Assembly
- Kynar PVDF Cable
- Compatible with Wide Variety of Chemicals
- Ruggedly Designed for Harsh Waste Water Environments
- Suitable for Waste, Salt, Brackish, or Fresh Water Systems
- EMI/RFI and Reverse Polarity Protection
- Lightning and Surge Protection
- Competitively Priced for OEM Applications
- ABS (American Bureau of Shipping) Approved

## SUBMERSIBLE

AST4520 Flush Diaphragm Liquid Level Sensor

### Applications

- ABS (American Bureau of Shipping) Approved
- Lift Stations - Wastewater, Storm Water, Industrial Applications
- Food Tanks
- Viscous Media Tanks
- Heavy Oil

### Performance @ 25°C (77°F)

<b>Accuracy</b>	< ±0.25% BFSL
<b>Stability (1 year)</b>	±0.25% FS, typical
<b>Over Range Protection</b>	2X Rated Pressure
<b>Burst Pressure</b>	5X or 1,250 PSI (whichever is less)
<b>Pressure Cycles</b>	>50 Million

### Environmental Data

#### Temperature

<b>Operating</b>	-40 to 80°C (-40 to 176°F)
<b>Storage</b>	-40 to 100°C (-40 to 212°F)

0-100% relative humidity, non-condensing

#### Thermal Limits

<b>Compensated Range</b>	0 to 55°C (32 to 132°F)
<b>TC Zero</b>	<±1.5% of FS
<b>TC Span</b>	<±1.5% of FS

#### Other

<b>Shock</b>	100G, 11 msec, 1/2 sine
<b>Vibration</b>	10G peak, 20 to 2000 Hz.
<b>EMI/RFI Protection:</b>	Yes
<b>Rating:</b>	IP-68

## SUBMERSIBLE

AST4520 Flush Diaphragm Liquid Level Sensor

### Electrical Data

<b>Output</b>	4-20mA	1-5VDC
<b>Excitation</b>	10-28VDC	10-28VDC
<b>Output Impedance</b>	>10k Ohms	<100 Ohms, Nominal
<b>Current Consumption:</b>	20mA, typical	<10mA
<b>Bandwidth</b>	(-3dB): DC to 250 Hz	(-3dB): DC to 1kHz
<b>Output Noise</b>	-	<2mV RMS
<b>Zero Offset:</b>	<±1% of FS (<±4% 1PSI)	<±1% of FS (<±4% 1PSI)
<b>Span Tolerance:</b>	<±2% of FS (<±4% 1PSI)	<±1.5% of FS (<±4% 1PSI)
<b>Output Load:</b>	0-800 Ohms@10-28VDC	10k Ohms, min
<b>Reverse Polarity Protection</b>	Yes	Yes

### Dimensions

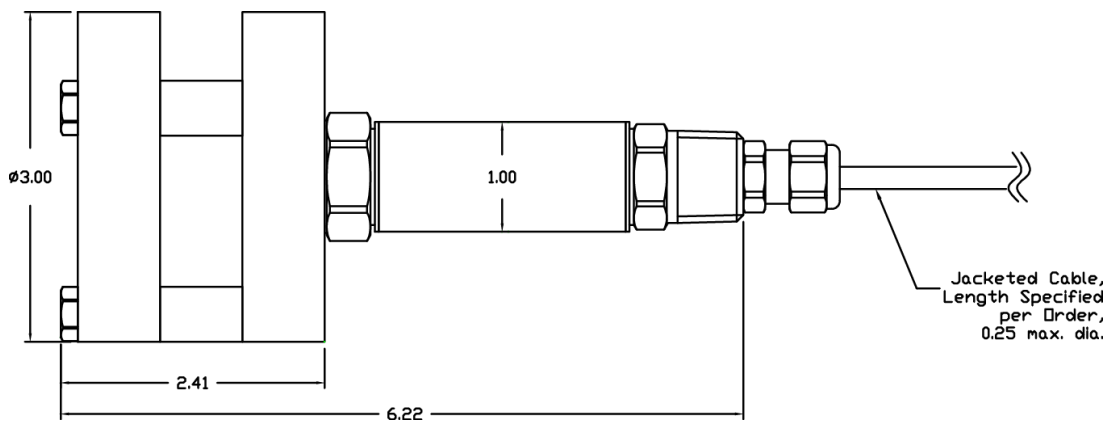

# SUBMERSIBLE

## AST4520 Flush Diaphragm Liquid Level Sensor

### UL Approved Barrier Installation / A01657

### CSA Approved Barrier Installation / A08949

Class I, Div. 1, Groups C,D  
 Class I, Zone 0 Ex Ia IIB T4  
 Class I, Zone 0 AEx Ia IIB T4  
 DR  
 Class I, Div. 1, Groups A,B,C,D  
 Class I, Zone 0 Ex Ia IIC T4  
 Class I, Zone 0 AEx Ia IIC T4  
 Hazardous Location

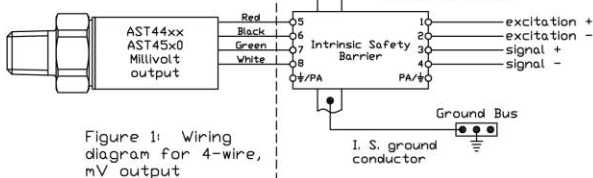

Figure 1: Wiring diagram for 4-wire, mV output

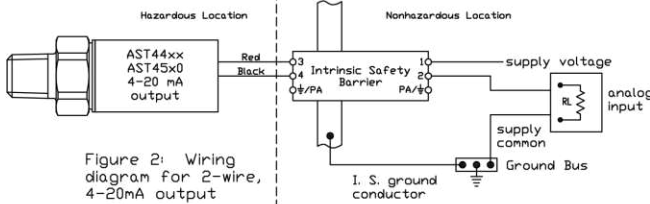

Figure 2: Wiring diagram for 2-wire, 4-20mA output

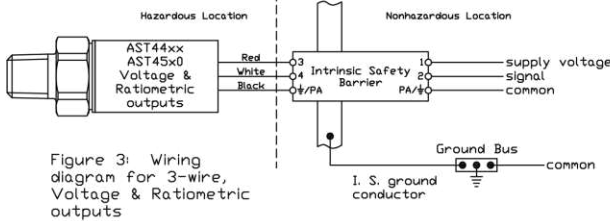

Figure 3: Wiring diagram for 3-wire, Voltage & Ratiometric outputs

Class I, Div. 1, Groups C,D  
 EXia IIB, T4  
 Class I, Zone 0, AEXia IIB, T4  
 DR  
 Class I, Div. 1, Groups A,B,C,D  
 EXia IIC, T4  
 Class I, Zone 0, AEXia IIC, T4  
 Hazardous Location

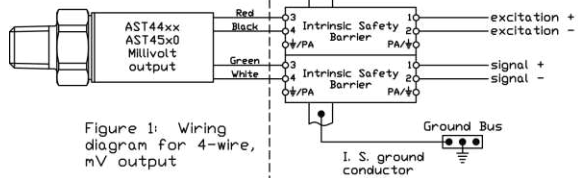

Figure 1: Wiring diagram for 4-wire, mV output

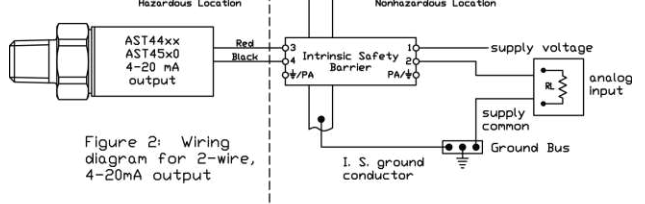

Figure 2: Wiring diagram for 2-wire, 4-20mA output

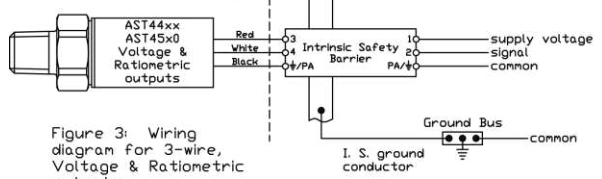

Figure 3: Wiring diagram for 3-wire, Voltage & Ratiometric outputs

The transducers listed below are designed for installation in EITHER Class I, Division 1, Groups C,D; Class I, Zone 0 Group IIB DR Class I, Division 1, Groups A,B,C,D; Class I, Zone 0 Group IIC hazardous locations when connected to Associated Apparatus as described in note 1.

#### Entity Parameters

Models AST4400, AST44LP, AST4500, AST4510, AST4520  
 Class I, Div. 1, Groups C,D; Class I, Zone 0 Ex Ia IIB T4  
 $V_{max} = 28V$

Model AST4401  
 Class I, Div. 1, Groups A,B,C,D; Class I, Zone 0 Ex Ia IIC T4; Class I, Zone 0 AEx Ia IIC T4  
 $V_{max} = 14.5V$

4-20mA with integral connector	4-20mA with upto 1000ft of integral cable	All EXCEPT 4-20mA with integral connector	All EXCEPT 4-20mA with upto 150ft of integral cable
$P_{max} = 651 mW$	$P_{max} = 651 mW$	$P_{max} = 651 mW$	$P_{max} = 651 mW$
$I_{max} = 93 mA$	$I_{max} = 93 mA$	$I_{max} = 93 mA$	$I_{max} = 93 mA$
$C_i = 0.391 \mu F$	$C_i = 0.434 \mu F$	$C_i = 0.643 \mu F$	$C_i = 0.649 \mu F$
$L_i = 0 \mu H$	$L_i = 0 \mu H$	$L_i = 0 \mu H$	$L_i = 0 \mu H$

$I_{sc}$  or  $I_o$  is the total current available from the Associated Apparatus under any condition.

#### 1. The following conditions must be satisfied:

- $V_{oc}$  or  $U_o \leq V_{max}$
- $I_{sc}$  or  $I_o \leq I_{max}$
- $P_o \leq P_i$  (if applicable)
- Total customer cable length for 4-20mA transmitters not to exceed 4000ft.
- Total customer cable length for all other transmitters not to exceed 150ft.
- Where the cable capacitance and inductance per foot are not known, the following values shall be used:  $C_{cable} = 60pF/ft$ ,  $L_{cable} = 0.2\mu H/ft$

#### 2. Control Room apparatus shall not generate in excess of 250V ( $U_{max}$ ).

#### 3. Canadian installations should be in accordance with Canadian Electrical Code, Part I. U.S. installations should be in accordance with Article 504 in the National Electrical Code, ANSI/NFPA 70.

#### Entity Parameters

Models AST4400, AST44LP, AST4500, AST4510, AST4520, AST4530  
 Class I, Div. 1, Groups C,D; EXia IIB, T4; Class I, Zone 0, AEXia IIB, T4  
 $V_{max} = 28Vdc$

Model AST4401  
 Class I, Div. 1, Groups A,B,C,D; EXia IIC, T4; Class I, Zone 0, AEXia IIC, T4  
 $V_{max} = 14.5Vdc$

4-20mA with integral connector	4-20mA with upto 1000ft of integral cable	All EXCEPT 4-20mA with integral connector	All EXCEPT 4-20mA with upto 150ft of integral cable
$P_{max} = 625 mW$	$P_{max} = 625 mW$	$P_{max} = 625 mW$	$P_{max} = 625 mW$
$I_{max} = 93 mA$	$I_{max} = 93 mA$	$I_{max} = 93 mA$	$I_{max} = 93 mA$
$C_i = 0.391 \mu F$	$C_i = 0.434 \mu F$	$C_i = 0.643 \mu F$	$C_i = 0.649 \mu F$
$L_i = 0$	$L_i = 155 \mu H$	$L_i = 0$	$L_i = 23.3 \mu H$

#### 1. For installation in accordance with Fig 2, barrier must be a CSA Certified, Single Channel grounded Shunt-Diode Zener Barrier or a Single Channel Isolating Barrier.

#### 2. For installations in accordance with Figs. 1 and 3, one dual-channel or two single-channel barriers may be used, where in either case, both channels have been certified for use together with combined entity parameters.

#### 3. The following conditions must be satisfied:

- $V_{oc}$  or  $U_o \leq V_{max}$
- $I_{sc}$  or  $I_o \leq I_{max}$
- $P_o \leq P_i$  (if applicable)
- $C_a$  or  $C_o \geq C_i + C_{cable}$
- $L_a$  or  $L_o \geq L_i + L_{cable}$

#### 4. Maximum non-hazardous area voltage must not exceed 250 V.

#### 5. Canadian installations should be in accordance with Canadian Electrical Code, Part I. U.S. installations should be in accordance with Article 504 in the National Electrical Code, ANSI/NFPA 70.

#### 6. A grounding method is not provided by the manufacturer as part of the integral design of the Transducer. For units which are connected through a grounded shunt diode safety barrier, ensure that the transducer is mounted to a surface which is at the same potential as the barrier ground.

#### 7. See user manual for installation conditions.

# SUBMERSIBLE

## AST4520 Flush Diaphragm Liquid Level Sensor

<b>AST4520</b>	<b>Y</b>	<b>00005</b>	<b>P</b>	<b>4</b>	<b>X</b>	<b>1</b>	<b>353</b>	<b>-SS</b>
----------------	----------	--------------	----------	----------	----------	----------	------------	------------

**Series Type**

**Process Connection**  
 Y= G1/2 with steel cage  
 T= G1/2 flush diaphragm without steel cage

**Pressure Range**  
 Insert 5-digit pressure range code. Ranges between 0-2.5 PSI and 0-15 PSI available. \*2.5 and 7.5 PSI Sensor must be ordered in inches of H.O.

Gauge PSIG	Pressure Code	Feet of Water Column @ 4°C (approx.)
0-15	00015	34.60
0-10	00010	23.07
0-7.5*	00208*	17.30
0-5	00005	11.53
0-2.5*	00069*	5.77

**Pressure Unit**  
 H= Inches H.O    P= PSI

**Outputs** (contact factory for 0.5-2.5V non-ratiometric (3-5VDC)  
 3= 1-5V  
 4= 4-20mA (2 wire loop powered)

**Electrical**  
 X= Optional Length (see options)

**Wetted Material**  
 1= 316L Sensor / 304 SS Housing / Kynar Cable

**Options (Cable Lengths):**  
 353 = 25 ft. (7.62 m)  
 354 = 50 ft. (15.24 m)  
 355 = 75 ft. (22.86 m)

**Approval**  
 (Left Blank)= UL ANSI/ISA 12.12.01 Class I Div 1 Intrinsically Safe Groups C, D (formerly UL913)  
 -SS= CSA157 Class I Div 1 Grps C, D Intrinsically Safe, ANSI/ISA 12.27.01 Single Seal and ATEX/IECEx Exia IIC Class I, Zone 0, T4

Note: CSA approved products require case/earth ground electrical connection. See wiring installation sheet for further details

### NORTH AMERICA

American Sensor Technologies, Inc. (AST),  
 a TE Connectivity Company  
 Tel: 1 800-522-6752  
 Email: [customercare.molive@te.com](mailto:customercare.molive@te.com)

### ASIA

Hong Kong Sensor Technologies (HKST),  
 a TE Connectivity Company  
 Tel: 86 0400-820-6015  
 Email: [customercare.shzn@te.com](mailto:customercare.shzn@te.com)

### TE.com/sensorsolutions

Measurement Specialties, Inc., a TE Connectivity company.

Measurement Specialties, TE Connectivity, TE Connectivity (logo) and EVERY CONNECTION COUNTS are trademarks. All other logos, products and/or company names referred to herein might be trademarks of their respective owners.

The information given herein, including drawings, illustrations and schematics which are intended for illustration purposes only, is believed to be reliable. However, TE Connectivity makes no warranties as to its accuracy or completeness and disclaims any liability in connection with its use. TE Connectivity's obligations shall only be as set forth in TE Connectivity's Standard Terms and Conditions of Sale for this product and in no case will TE Connectivity be liable for any incidental, indirect or consequential damages arising out of the sale, resale, use or misuse of the product. Users of TE Connectivity products should make their own evaluation to determine the suitability of each such product for the specific application.

© 2015 TE Connectivity Ltd. family of companies All Rights Reserved.