

PTQ9 Pressure Temperature Quill

Model Code

PTQ9 - T1 - T2

PTQ9 Pressure Temperature Quill - 0.260" Bore - 90°

T1	Process Connection	"A" (Root)	"B" (Tip)
34	3/4" NPT	0.875"	0.875"
10	1" NPT	1.063"	1.063"

T2	Quill "U" Length (inches)	"Stem" Length (inches)
1	1"	7.5"
1.5	1.5"	8.0"
2.5	2.5"	9.0"
4.5	4.5"	11.25"
6	6"	12.50"
8	8"	14.50"
10	10"	16.50"

Outline & Dimensions

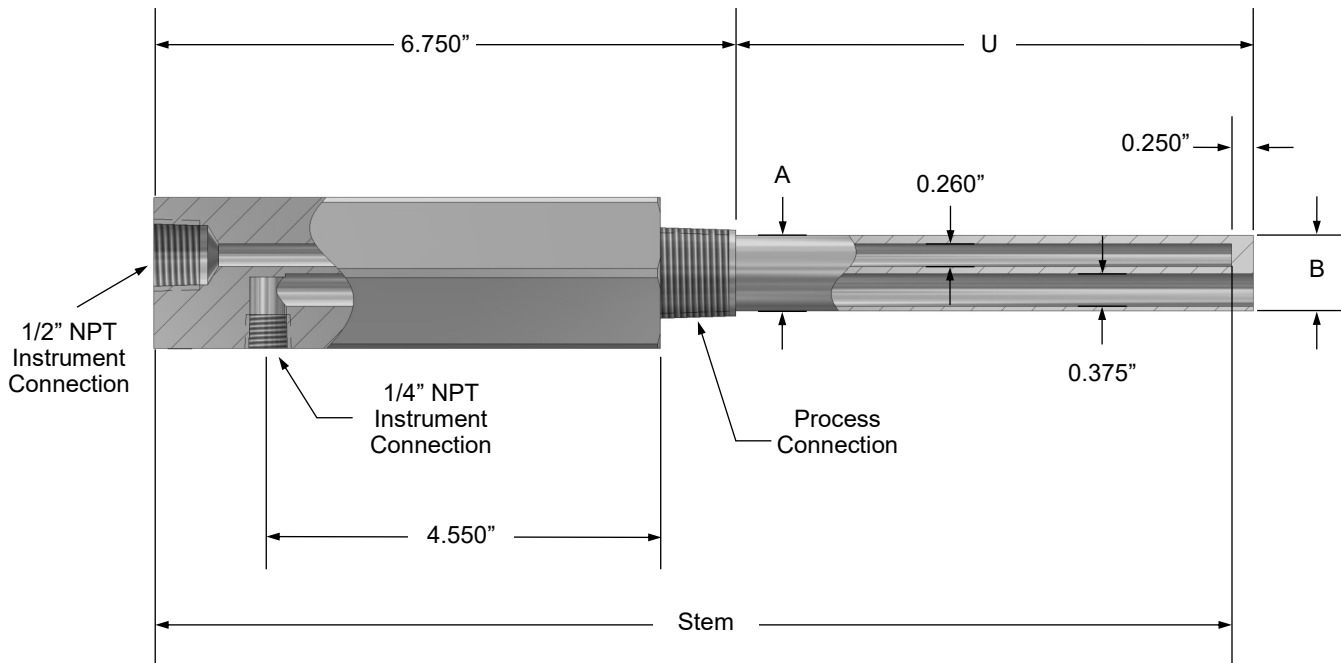

NOTES:

1. Part number example: PTQ9-34-1.5
2. Material is 316/316L stainless steel
3. MAWP 3/4" NPT: 3926 psi at 302°F & 1" NPT: 6251 psi at 649°F
4. Canadian Registration Number (CRN) available
5. Temperature sensor probe outside diameter must be 0.250"